

Connecting sets automatic Type I

Item description/product images



Description

Material:

Steel.

Version:

Electro zinc-plated.

Note:

The connecting sets are used to connect two aluminium profiles at right angles. They allow free position of the profiles.

No profile machining is necessary. The connector is screwed into the profile slot from the front (left-hand thread). The connector has a self-tapping thread. The use of lubricants is recommended.

Connecting sets automatic should always be used opposite each other in pairs.

Drawings

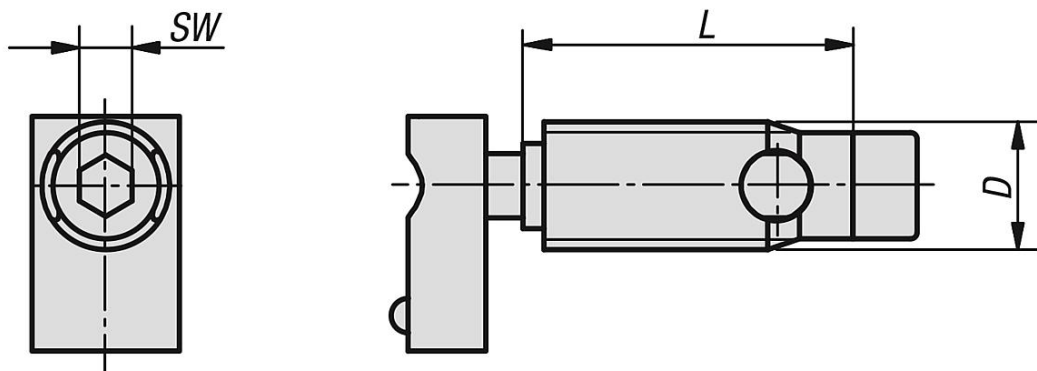

Overview of items

Connecting sets automatic Type I

Order No.	Type	Slot width	D	L	SW
K1036.06	I	6	10	27	4
K1036.08	I	8	12	31	5